

Model(s):
SF-BI30-E
SF-BI36-E

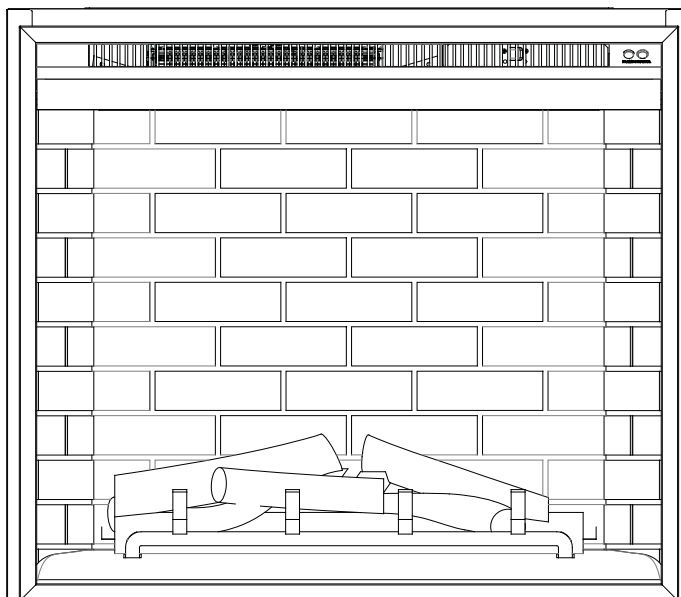

NOTICE



DO NOT DISCARD THIS MANUAL

- Important operating and maintenance instructions included.
- Read, understand and follow these instructions for safe installation and operation.
- Leave this manual with party responsible for use and operation.



Congratulations!

Congratulations on selecting a SimpliFire Electric Fireplace, an elegant and clean alternative to wood & gas burning fireplaces. The SimpliFire electric fireplace you have selected is designed to provide the utmost in safety, reliability, and efficiency.

READ CAREFULLY BEFORE ATTEMPTING TO ASSEMBLE, INSTALL, OPERATE, OR MAINTAIN THIS PRODUCT.

PROTECT YOURSELF AND OTHERS BY OBSERVING ALL SAFETY INFORMATION. FAILURE TO COMPLY WITH INSTRUCTIONS COULD RESULT IN PERSONAL INJURY AND/OR PROPERTY DAMAGE.

⚠ WARNING: To reduce risk of fire, electrical shock, or personal injury, read all instructions before using appliance.

**INSTALLER: DO NOT DISCARD THIS MANUAL -
LEAVE FOR HOMEOWNER - SAVE THESE INSTRUCTIONS**

1 IMPORTANT INSTRUCTIONS

IMPORTANT SAFETY INSTRUCTIONS

**WARNING! Risk of Fire! Risk of Burns!
Risk of Electrical Shock!**

DO NOT:

- Install or operate damaged appliance
- Modify appliance
- Operate the appliance without fully assembling all components

The following actions are strictly prohibited.

- Installation other than as instructed by *Hearth & Home Technologies Inc.*
- Installation and/or use of any component part not approved by *Hearth & Home Technologies Inc.*

Hearth & Home Technologies Inc. disclaims any responsibility for, and the warranty and agency listing will be voided by the above actions.

When using electrical appliances, basic precautions should always be followed to reduce the risk of fire, electric shock, and injury to persons, including the following:

- Read all instructions before installing this appliance.
- This appliance is hot when in use. To avoid burns, do not let bare skin touch hot surfaces. Keep combustible materials such as furniture, pillows, bedding, papers, clothes, etc. and curtains at least 3 ft. (0.9 m) from the front of the appliance and keep them away from the sides and rear
- Extreme caution is necessary when any appliance is used by or near children or invalids and whenever the appliance is left operating and unattended.
- Do not operate any appliance if it malfunctions. Disconnect power at service panel and have appliance inspected by a reputable electrician before reusing.
- Do not insert or allow foreign objects to enter any ventilaion or exhaust opening as this may cause an electric shock or fire, or damage the appliance.
- To prevent a possible fire, do not block appliance connection fan air intakes or exhaust in any manner.
- A appliance has hot and arcing or sparking parts inside. Do not use it in areas where gasoline, paint, or flammable vapors or liquids are used or stored.
- Use this appliance only as described in this manual. Any other use not recommended by the manufacturer may cause fire, electric shock, or injury to persons.
- Do not operate any appliance with a damaged cord or plug or after the appliance malfunctions, has been dropped or damaged in any manner. Return appliance to authorized service facility for examination, electrical or mechanical adjustment or repair.
- Do not use outdoors.
- The appliance is not intended for use in bathrooms, laundry areas and similar indoor locations. Never locate appliance where it may fall into a bathtub or water container.
- Do not run cord under carpeting. Do not cover cord with throw rugs, runners, or the like. Arrange cord away from traffic areas and where it will not be tripped over. Do not tightly coil cord.
- Always use properly grounded, fused and polarized outlets.
- Always use ground fault protection where required by electrical code.
- To disconnect appliance, turn controls to "OFF" then remove plug from outlet.
- Always disconnect power before performing any cleaning, maintenance or relocation of the appliance.
- To prevent a possible fire, do not burn wood or other materials in this appliance.
- To prevent electrical shock or fire, always use a certified electrician should new circuits be required.
- When transporting or storing the appliance, keep in a dry place free from excess vibration and store to avoid damage.
- Avoid use of an extension cord because an extension cord may overheat and cause a fire. However if you have to use an extension cord, the cord should be No. 14 AWG minimum size and rated to not less than 1875 watts.

WARNING! DO NOT operate fireplace before reading and understanding operating instructions. Failure to operate fireplace according to operating instructions could cause fire or injury.

WARNING! Improper installation, adjustment, alteration, service or maintenance can cause injury or property damage. Refer to owner's information manual provided with this appliance. For assistance or additional information consult a qualified installer, service agency or your dealer .

NOTICE! This fireplace is not intended for use as a primary heat source and should not be factored as such in residential heating calculations.

SAVE THESE INSTRUCTIONS

▲ Safety Alert Key:

- **WARNING!** Indicates a hazardous situation which, if not avoided could result in death or serious injury.
- **CAUTION!** Indicates a hazardous situation which, if not avoided, could result in minor or moderate injury.

Table of Contents

1 IMPORTANT INSTRUCTIONS

A. Important Information 2
B. Warranty 4

2 GENERAL INFORMATION

A. Appliance Certification 5
B. Unpacking and Inspecting Appliance 5
C. Model and Serial Number Information 5

3 GETTING STARTED

A. Parts and Hardware 6
B. Tools and Supplies Needed 6
C. Appliance Dimensions 6
D. Location 7
E. Clearance to Combustibles 7
F. Electrical Supply Circuit Requirements 7

4 INSTALLATION

A. Selecting Appliance Location 8
B. Appliance Preparation 9
C. Installation into Existing Fireplace 10
D. Installation into New Construction 10
E. Constructing the Chase 10
F. Electrical Connection 10
G. Finishing Fireplace Wall 10

5 OPERATING INSTRUCTIONS

A. Manual Switch Function: 11
B. Operating by Remote Control. 12
C. Resetting Temperature Cutoff Switch. 12

6 MAINTENANCE

A. Maintenance 13
B. Cleaning 13
C. Electrical Wiring Diagram. 13
D. Servicing. 13
E. Service Parts List 14
F. Contact Information 16

B. Warranty

SimpliFire™ WARRANTY

Hearth & Home Technologies, on behalf of its brand SimpliFire ("SimpliFire"), extends the following warranty for electric fireplaces that were purchased from a SimpliFire authorized dealer.

WARRANTY COVERAGE:

SimpliFire warrants to the original owner of the SimpliFire fireplace, and to any transferee taking ownership of the SimpliFire fireplace within one year following the date of original purchase, that the SimpliFire fireplace will be free from defects in materials and workmanship at the time of manufacture. If a SimpliFire fireplace is found to be defective in materials or workmanship during the applicable warranty period, HHT will, at its option, repair or replace the SimpliFire fireplace. SimpliFire, at its own discretion, may fully discharge all of its obligations under such warranties by replacing the product itself or refunding the verified purchase price of the product itself. The maximum amount recoverable under this warranty is limited to the purchase price of the product. This warranty is subject to conditions, exclusions and limitations as described below.

WARRANTY PERIOD:

Warranty coverage begins on the date of original purchase. In the case of new home construction, warranty coverage begins on the date of first occupancy of the dwelling or six months after the sale of the product by an independent, authorized SimpliFire dealer/ distributor, whichever occurs earlier. The warranty shall commence no later than 24 months following the date of product shipment from HHT, regardless of the installation or occupancy date.

WARRANTY CONDITIONS:

This warranty only covers SimpliFire fireplaces that are purchased through a SimpliFire authorized dealer or distributor. A list of SimpliFire authorized dealers is available on the SimpliFire websites.

WARRANTY EXCLUSIONS:

This warranty does not cover the following:

- Changes in surface finishes as a result of normal use. As a heating appliance, some changes in color of interior and exterior surface finishes may occur. This is not a flaw and is not covered under warranty.
- Damage to printed, plated, or enameled surfaces caused by fingerprints, accidents, misuse, scratches, melted items, or other external sources and residues left on the plated surfaces from the use of abrasive cleaners or polishes.
- Repair or replacement of parts that are subject to normal wear and tear during the warranty period. These parts include: paint, batteries and the discoloration of glass.
- Damages resulting from: (1) failure to install, operate, or maintain the appliance in accordance with the installation instructions, operating instructions, and listing agent identification label furnished with the appliance; (2) shipping or improper handling; (3) improper operation, abuse, misuse, continued operation with damaged, corroded or failed components, accident, or improperly/ incorrectly performed repairs; (4) environmental conditions (5) installation or use of components not supplied with the appliance or any other components not expressly authorized and approved by HHT; (6) modification of the appliance not expressly authorized and approved by HHT in writing; and/or (7) interruptions or fluctuations of electrical power supply to the appliance.
- Our obligation under this warranty does not extend to the SimpliFire fireplace's capability to heat the desired space.

This warranty is void if:

- The fireplace is subject to or operated in atmospheres contaminated by chlorine, fluorine, or other damaging chemicals.
- The fireplace is subjected to or operated in places with prolonged periods of dampness or condensation or weather. Examples include but are not limited to outdoors, porches, and laundry rooms.
- There is any damage to the fireplace or other components due to water or weather damage.

LIMITATIONS OF LIABILITY:

- The owner's exclusive remedy and SimpliFire's sole obligation under this warranty, under any other warranty, express or implied, or in contract, tort or otherwise, shall be limited to replacement, repair, or refund, as specified above. In no event will SimpliFire be liable for any incidental or consequential damages caused by defects in the appliance. Some states do not allow exclusions or limitation of incidental or consequential damages, so these limitations may not apply to you. This warranty gives you specific rights; you may also have other rights, which vary from state to state. EXCEPT TO THE EXTENT PROVIDED BY LAW, SIMPLIFIRE MAKES NO EXPRESS WARRANTIES OTHER THAN THE WARRANTY SPECIFIED HEREIN. THE DURATION OF ANY IMPLIED WARRANTY IS LIMITED TO DURATION OF THE EXPRESSED WARRANTY SPECIFIED ABOVE.

2 GENERAL INFORMATION

A. Appliance Certification

MODELS: SF-BI30-E, SF-BI36-E
LABORATORY: CSA International
TYPE: Electric Air-Heaters Fixed and Location-Dedicated Electric Room Heaters
STANDARD: UL 2021 (2nd Edition) CSA C22.2 No 46-M1988

NOTICE: This installation must conform with local codes.

NOT INTENDED FOR USE AS A PRIMARY HEAT SOURCE.

This appliance is tested and approved as either supplemental room heat or as a decorative appliance. It should not be factored as primary heat in residential heating calculations.

Note: The device complies with Part 15 of the FCC Rules. Operation is subject to the following two conditions:

1. This device may not cause harmful interference, and
2. This device must accept any interference received, including interference that may cause undesired operation.

This equipment uses and can radiate radio frequency energy and, if not installed and used in accordance with the instructions, may cause harmful interference to radio or television reception, which can be determined by turning the equipment off and on. The user is encouraged to try to correct the interference by one or more of the following measures:

- Reorient or relocate the receiving antenna
- Increase the separation between the equipment and the receiver.
- Connect the equipment into an outlet on a circuit different from that to which the receiver is connected.
- Consult the dealer or an experienced radio/TV technician for help.

B. Unpacking and Inspecting Appliance

WARNING! DO NOT use this Electric Fireplace if any part has been under water. Immediately call a qualified service technician to inspect and to replace any part of the electrical system if necessary. Keep plastic wrapping away from children.

- Carefully remove the appliance and components from the packaging. Discard packaging.
- Carefully inspect components for any damage.
- Reference parts list to verify all parts have been received.
- Report to your dealer any missing or damaged parts.
- Read all the instructions before starting the installation. Follow these instructions carefully during the installation to ensure maximum safety and benefit.

C. Model and Serial Number Information

The model and serial number information is located on the rating plate. The rating plate is located on the upper wall of the fireplace behind glass front.

ELECTRIC FIREPLACE	
MODEL	SF-BI30-E
VOLTAGE	120V AC
FREQUENCY	60 Hz
AMPERAGE	12.5 A
WATTS	1500 W
SERIAL No.:	



C US
249163

MADE IN CHINA

ELECTRIC FIREPLACE	
MODEL	SF-BI36-E
VOLTAGE	120V AC
FREQUENCY	60 Hz
AMPERAGE	12.5 A
WATTS	1500 W
SERIAL No.:	



C US
249163

MADE IN CHINA

Homeowner Reference Information

We recommend that you record the following pertinent information about your fireplace.

Model Name: _____ Date purchased/installed: _____

Serial Number: _____ Location on fireplace: _____

Dealership purchased from: _____ Dealer Phone: _____

Notes: _____

3 GETTING STARTED

A. Parts and Hardware

Parts and Hardware List	
Part	Quantity
Fireplace	1
Instruction Manual	1
Remote Control	1
AAA Battery	2
Mounting Bracket	4
Screw ST4x8	8
Screw ST4x12	8

B. Tools and Supplies Needed

Before beginning the installation be sure that the following tools and building supplies are available.

- Tape measure
- Pliers
- Hammer
- Gloves
- Magnetic Phillips screwdriver
- Safety glasses
- Flat blade screwdriver

C. Appliance Dimensions

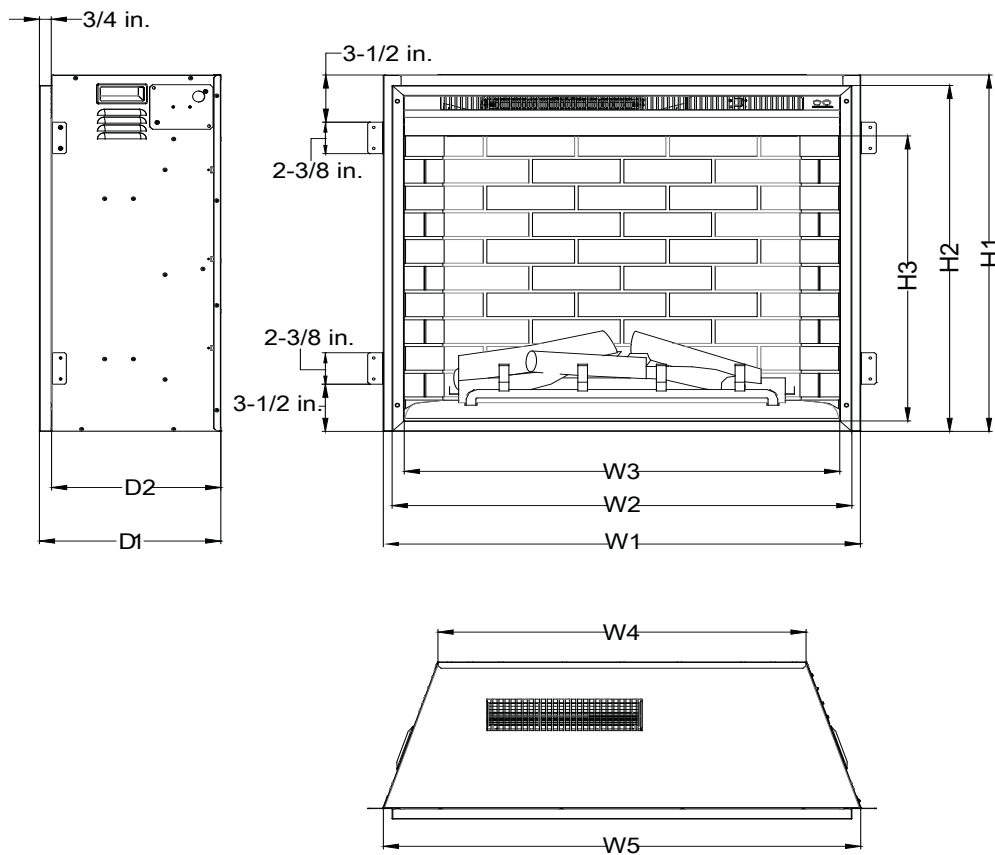

units: inches

MODEL	SHELL SIZE			TRIM SIZE		FLAME VIEW		OTHER SIZE		
	W1	H1	D1	W2	H2	W3	H3	D2	W4	W5
SF-BI30-E	31-1/8	26-3/4	11-13/16	29-15/16	26	28-11/32	21-13/32	11	24	31-1/8
SF-BI36-E	37	31-1/4	11-13/16	35-13/16	30-3/8	34-1/4	25-7/8	11	29-7/8	37

D. Location

When choosing a location for your fireplace ensure that the general rules are followed:

- For best results, install out of direct sunlight.
- Power supply service must be installed within proximity of electric fireplace prior to finishing to avoid reconstruction.
- See Figure 3.C for appliance dimensions and to determine location of appliance installation.

E. Clearance to Combustibles

Minimum Clearance to Combustibles

Sides.....0 in.
Floor.....0 in.
Top.....0 in.
Back.....0 in.
Front.....36 in.
Mantels.....See Figure 3.1

WARNING! Risk of Fire! Keep electrical cords, drapery, furnishings or other combustibles at least 3 ft. (0.9 m) from the front of the electric fireplace, and away from the sides or rear.

F. Electrical Supply Circuit Requirements

Plan the location of the appliance so that it will have adequate electric power. A 15 AMP, 120V/60hz. circuit is required. Additional appliances on the same circuit as this appliance may exceed the current rating of that circuit. A dedicated circuit is not required, but is preferred to prevent circuit breaker trips or fuse failure.

Reference Section 4.E for more complete detail on completing electrical installation.

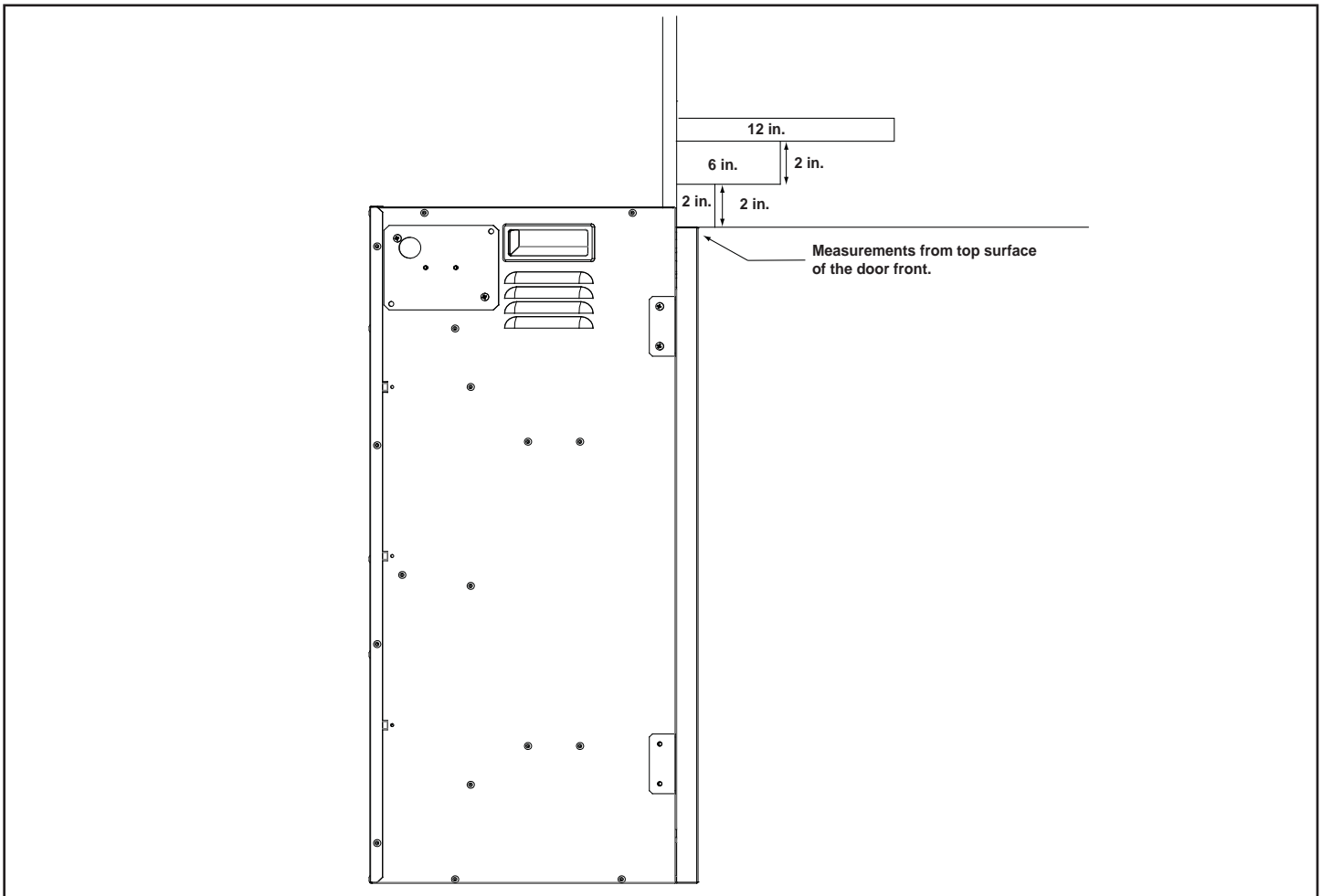

Figure 3.1 Minimum Vertical and Maximum Horizontal Dimensions of Combustible Mantels.

4 INSTALLATION

A. Selecting Appliance Location

When selecting a location for the appliance it is important to consider the required clearances to walls (see Figure 4.1).

WARNING! Risk of Fire or Burns! Provide adequate clearance around air openings and for service access. Due to high temperatures, the appliance should be located out of traffic and away from furniture and draperies.

NOTICE: Illustrations reflect typical installations and are FOR DESIGN PURPOSES ONLY. Illustrations/diagrams are not drawn to scale. Actual installation may vary due to individual design preference.

This product can be built into new construction or an existing factory-built fireplace. Reference Sections 4.A - 4.D for specific information for your installation.

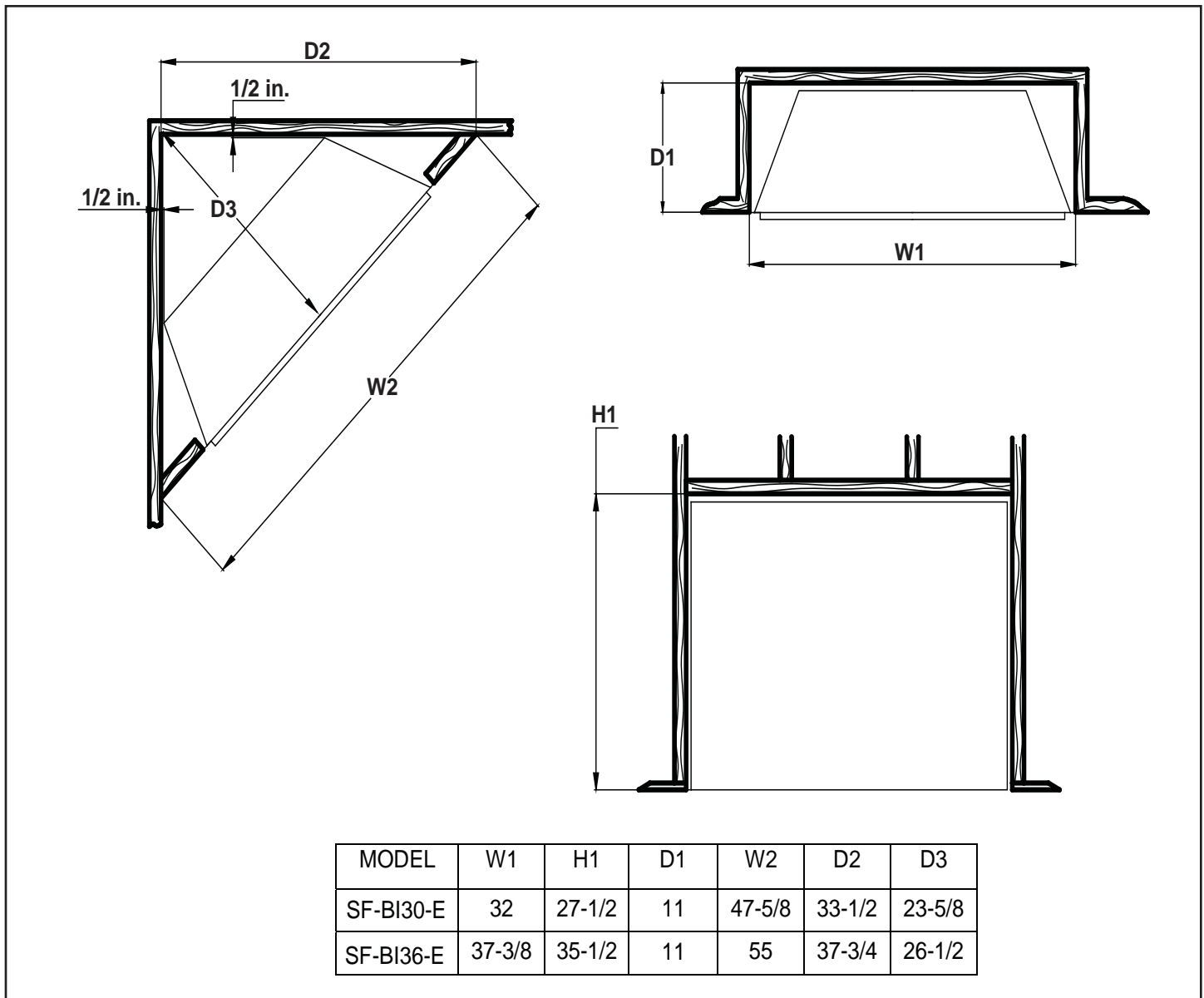

Figure 4.1 Clearance Requirements

B. Appliance Preparation

Install mounting brackets (4) by aligning them with the pre-drilled holes located on the side of the appliance. Use two screws (ST4 x 8) per bracket to secure to the appliance. See Figure 4.2 and 4.3.

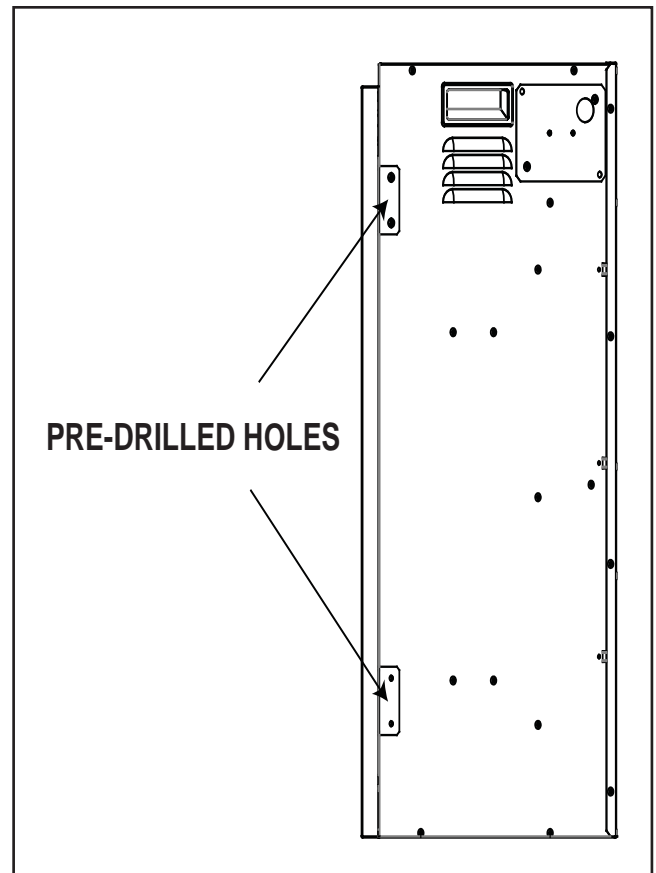

Figure 4.2 Pre-drilled Hole Location

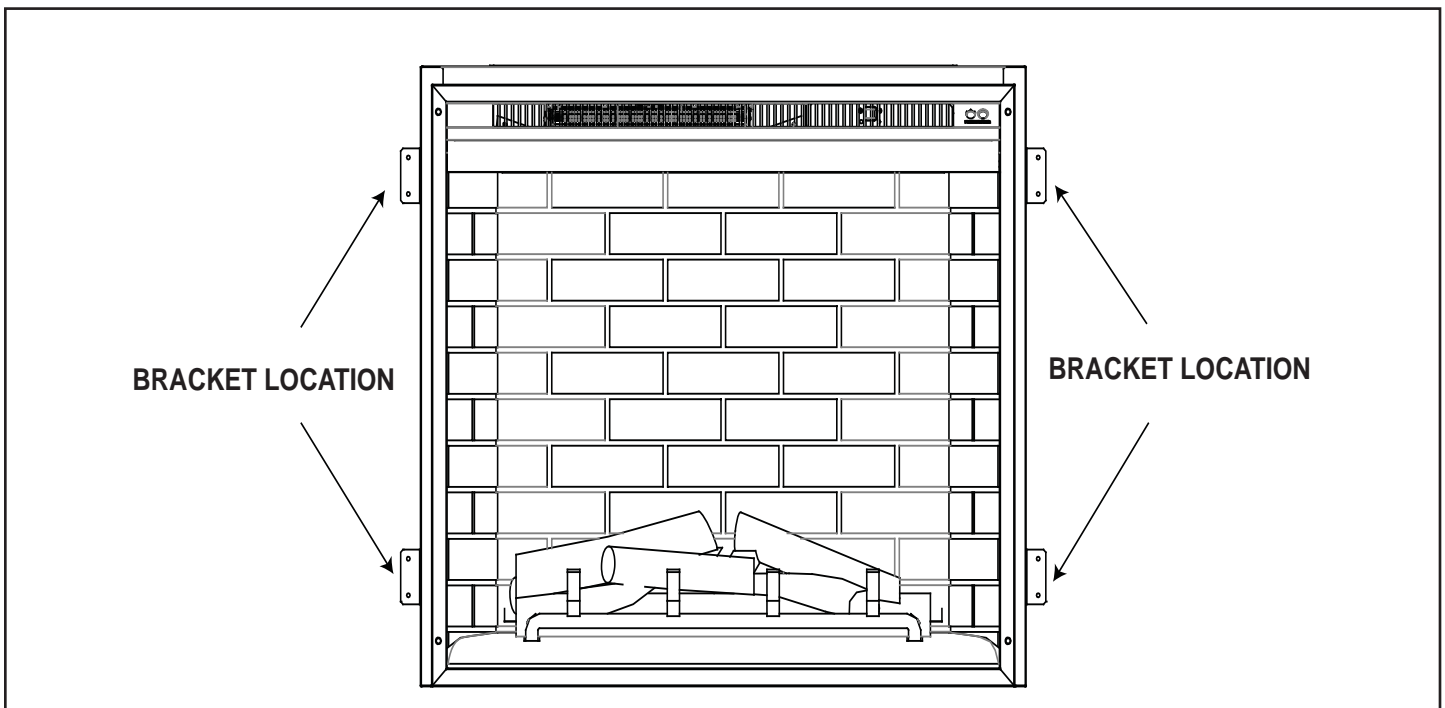

Figure 4.3 Bracket Locations

C. Installation into Existing Fireplace

1. Seal all drafts with non-fibrous insulation materials to prevent debris or water from falling from the chimney to electric fireplace.
2. Close or seal off the chimney flue and close damper (if applicable) to prevent rain infiltration.
3. Do not install in an existing fireplace that is prone to dampness.
4. A provision must be made for the appliance to be connected to power within existing firebox, or on an adjacent wall.

D. Installation into New Construction

Position the fireplace within the opening in the framing. Level the fireplace with shims if necessary. Attach the fireplace to the framing with the four provided brackets and screws or nails.

E. Constructing the Chase

A chase is a vertical box-like structure built to enclose the electrical appliance. Chases should be constructed in the manner of all outside walls of the home to prevent cold air drafting problems. The chase should not break the outside building envelope in any manner.

Walls, ceiling, base plate and cantilever floor of the chase should be insulated. Vapor and air infiltration barriers should be installed in the chase as per regional codes for the rest of the home. Additionally, in regions where cold air infiltration may be an issue, the inside surfaces may be sheetrocked and taped for maximum air tightness.

F. Electrical Connection

Note: All wiring must be completed prior to finishing the unit.

WARNING! Risk of Fire, Electrical Shock, and Injury! Electrical wiring must comply with local building codes and other applicable regulations.

WARNING! Risk of Shock! Label all wires prior to disconnection when servicing product. Wiring errors can cause improper and dangerous operation. Verify proper operation after servicing.

A 15 AMP, 120 Volt, 60 Hz. circuit with a properly grounded outlet is required. Use minimum size 14 AWG for supply connection to 120 volt, 60 Hz, 15 AMP branch circuit. Use copper wire only. The supply wiring should be properly grounded. A dedicated circuit is recommended as other appliances on the circuit may cause the breaker to trip or fuse to blow when the appliance is operating.

1. Remove the screws securing the junction box cover plate on the upper right side of appliance.
2. Pull electrical wires from outside appliance through the 3/4 in. hole in the junction box cover plate.
3. Secure electrical wire to cover plate with Romex stain relief connector (not provided).
4. Connect three wires to the terminal block in the appliance junction box.
5. Ensure all terminal block connections are tight.
6. Replace the cover and retaining screws.
7. All components and wiring may be inspected by removing the top inner panel through the fireplace front opening.

G. Finishing Fireplace Wall

Combustible or non-combustible materials may be used to finish up to the fireplace glass frame. Ensure that you leave adequate room to remove and replace the glass frame. See Figure 4.4.

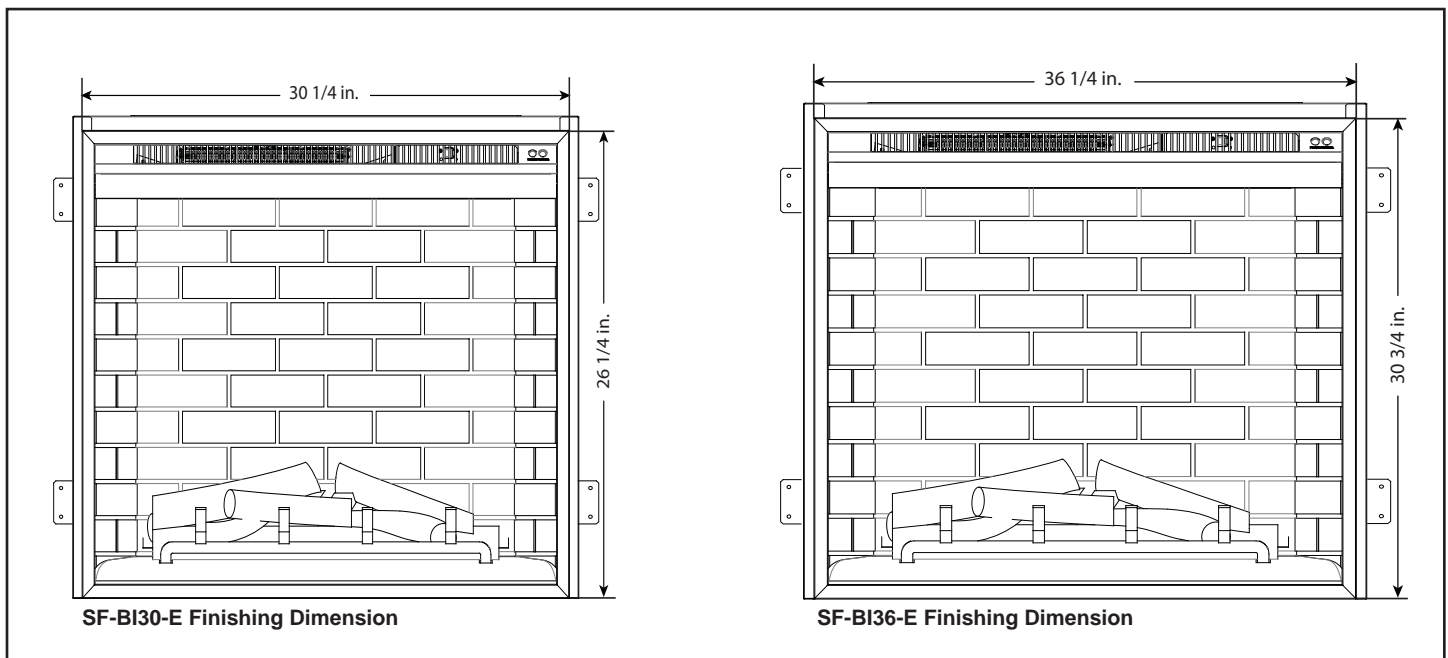

Figure 4.4 Finishing Dimensions

5 OPERATING INSTRUCTIONS

WARNING! Do not operate the unit if it is damaged or has malfunctioned. If you suspect the unit is damaged, call a qualified service technician to inspect and replace any part of the electrical system if necessary.

Note: A harmless slight brief odor may occur during first use or after prolonged period of storage.

A. Manual Switch Function:

The appliance can be operated by both remote control and manual button. Once the unit has been properly connected to a grounded electrical circuit, the unit can be turned ON by pressing the Flame button. In any active Flame mode, the Heater button function is available. If the Flame effect is OFF, there is no Heater button function. See Figure 5.1.

Flame Button

By pressing the FLAME button, the unit will cycle through four flame effects.

Heater Button

- Press the heater button once to turn 750W power on. Appliance will beep and illuminate 1 red LED.
- Press again turns 1500W power on. Appliance will beep and illuminate 2 red LEDs.
- Press third time turns heater off.

NOTE:

There is a brief delay between the heater command and the heating turning ON. When the appliance receives a heater ON command, the appliance blower will turn ON for 8 seconds before the heater turns ON. There is also an 8 second delay between heater off and blower shutdown.

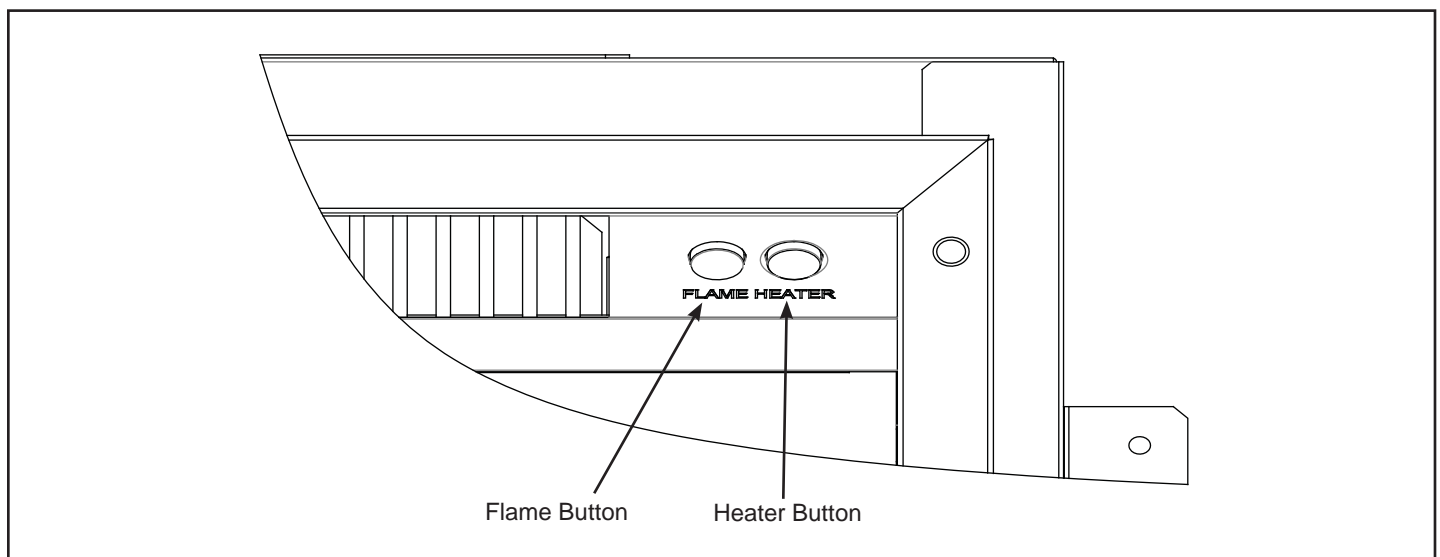

Figure 5.1 Manual Operating Switches

B. Operating by Remote Control

- Make sure batteries are properly installed in Remote Control.
 - Battery requirements 2 x AAA batteries (included)
- The effective range of the remote is up to 13 ft.
- The remote control must be within the 13 ft. range and also be pointed directly at the face of the appliance. For best results, position the remote control within 45 degrees of the face of the appliance





C. Resetting Temperature Cutoff Switch

The heater is protected with a safety device to prevent overheating. Should the heater overheat, an automatic cutoff will turn the heater OFF. It will not turn ON automatically without being reset. If it overheats for any reason, it can be reset by:

1. Turn appliance to off
2. Unplug unit and wait 5 minutes
3. Plug in and turn on.

CAUTION: *If appliance overheats repeatedly, discontinue use and call customer / technical support.*

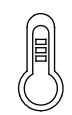
CAUTION: *If you need to continuously reset the heater, unplug the appliance and call your customer/technical support.*

ICON	TITLE	FUNCTION	REMOTE LCD DISPLAY	FIREPLACE RESPONSE
	POWER	The POWER button will turn the fireplace on. It will also put the fireplace in a standby mode. This will turn off all functions at once but will hold the settings in memory except Heater function. The unit will turn on at the same settings by pressing the power button again.	LCD illuminates and displays flame status icon and temperature set point.	Fireplace emits single audible beep to confirm command to transition to ON or STANDBY state
	FLAME	By pressing the FLAME button, the unit will cycle through four flame effects.	LCD illuminates and displays flame status icon.	Fireplace emits single audible beep to confirm command to transition between four FLAME states.
	HEATER	Press Heater button once 750W heater turns on. Press Heater button twice 1500W turns on, Press Heater button three times, turns off heater.	LCD illuminates and displays heater status icon.	Fireplace emits signal audible beep to confirm command to transition between HEATER states. Fireplace displays one red LED for 8 seconds to confirm low heater command. Fireplace displays two red LED for 8 seconds to confirm high heater command.
	THERMOSTAT	Pressing the Temperature button adjusts the heaters response to the ambient temperature conditions in the room. Temperature adjusts from 16 °C - 28 °C (61 °F - 82 °F). Power button must be on to set from °C to °F. Hold for 3 seconds and the LCD display from °C to °F.	Remote displays the temperature. If in Stand-by mode, temperature displays but cannot be adjusted.	Fireplace emits single audible beep to confirm command to change desired temperature setpoint.
	TIMER	Pressing the Timer button sets the time desired for the fireplace to run. The Timer can be set from .5 hour up to 9 hours in 1 hour increments.	Remote will display the time setting selected. If in Stand-by mode time will display but cannot be adjusted.	Fireplace emits single audible beep to confirm command to transition between four FLAME states.
	LIGHT	Pressing the spotlight button will switch the spotlight on and off.	No indicator.	Fireplace will emit one audible beep as it transitions between spotlight on and off states.

6 MAINTENANCE

A. Maintenance

WARNING! Risk of Shock! Always unplug the cord before moving or servicing. Do not immerse appliance in water.

- Always turn OFF the appliance and disconnect the cord from the electrical outlet before cleaning your appliance.
- Light accumulated dust may be removed from the appliance with a soft cloth or vacuum cleaner.
- Wipe the exterior surfaces of the appliance occasionally with a slightly damp cloth using a solution of mild detergent and water. Dry thoroughly before operating the appliance.

CAUTION! Do not allow water to run into the interior of the appliance as this could create a fire or electric shock. Always disconnect electrical service before servicing appliance.

- The fan motor is factory lubricated for life and will not require further lubrication.
- Store appliance in a clean dry place when not in use.

WARNING! Risk of Fire! To reduce risk of fire, do not store or use gasoline or any other flammable vapors or liquids in the vicinity of the appliance.

WARNING! Risk of Electrical Shock! Any other servicing needed must be performed by an authorized service representative. Do not attempt to service the unit yourself.

B. Cleaning

Cleaning Glass

Dust particles can be removed by buffing lightly with a clean dry cloth. Fingerprints and other marks can be cleaned with a cloth dampened with a quality household glass cleaner. The glass should be completely dried with a lint free cloth or paper towel. Do not use abrasive cleaners on glass surface. Do not spray liquids directly onto any surface.

Metal Surface

Dust particles can be removed by buffing lightly with a clean dry cloth. A damp cloth can be used to clean painted surfaces. Do not use abrasive cleaners. Do not spray liquids directly on to any surface,

C. Electrical Wiring Diagram

See Figure 6.1.

D. Servicing

Except for installation and cleaning described in this manual, an authorized service representative should perform any other servicing.

WARNING! Risk of Electrical Shock! Any other servicing needed must be performed by an authorized service representative. Do not attempt to service the unit yourself.

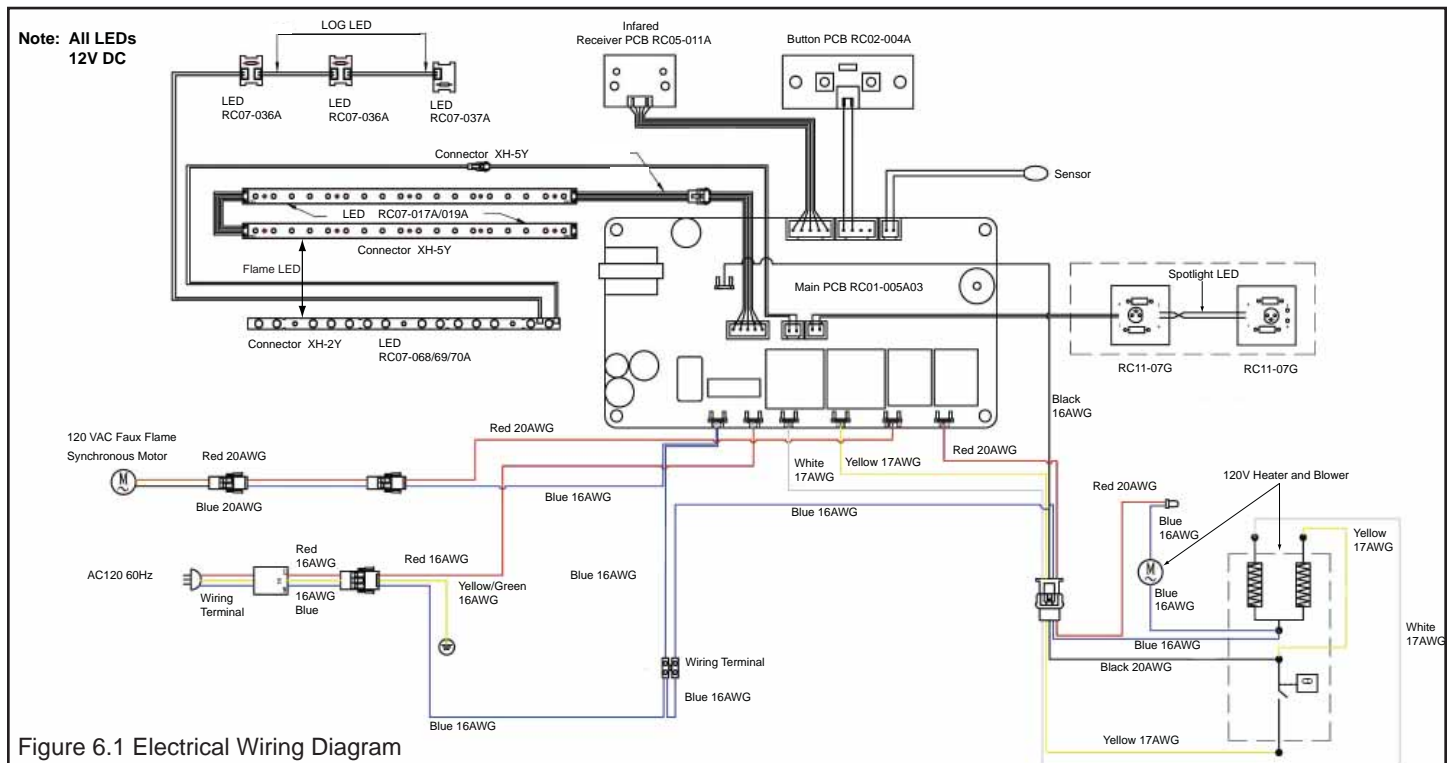

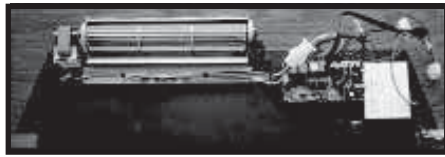

#1 Heater Tray



#2 Rotisserie Motor

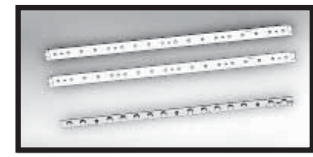

#3 LED Strips



#4 Log/Grate Assembly



#5 Refractory Kit



#6 Flame Screen

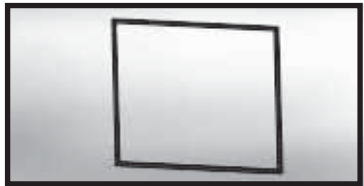

#7 Front



#8 Glass



#9 Remote

IMPORTANT: THIS IS DATED INFORMATION. Parts must be ordered from a dealer or distributor. **Hearth and Home Technologies does not sell directly to consumers.** Provide model number and serial number when requesting service parts from your dealer or distributor.



Stocked at Depot

ITEM	DESCRIPTION	COMMENTS	PART NUMBER	Stocked at Depot
1	Heater Assembly includes Control Board and Fan		HEATER-BI30	Y
2	Rotisserie Motor, Rod & 3 screws		ROTISSERIE-BI30	Y
3	LED Strips, 3 Strips		LED-BI30	Y
4	Log/Grate Assembly		LOGS-BI30	Y
5	Refractory Kit		REFRACTORY-BI30	Y
6	Flame Screen		FLAME-BI30	Y
7	Front		FRONT-BI30	Y
8	Glass		GLA-BI30	Y
9	Remote		REMOTE-SF-ELEC	Y
	Hardware Bag		HRDW-BI	Y
	Includes: Mounting Brackets, Screw (ST4 x 8), Screws (ST4 x 12)			
	Installation Manual		2040-900	

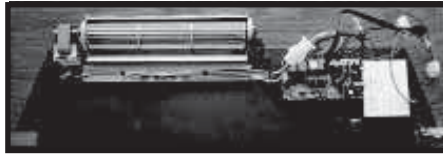

#1 Heater Tray



#2 Rotisserie Motor

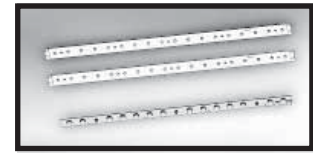

#3 LED Strips



#4 Log/Grate Assembly



#5 Refractory Kit



#6 Flame Screen

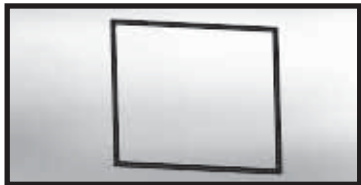

#7 Front

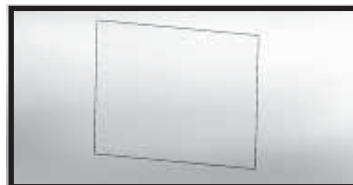

#8 Glass

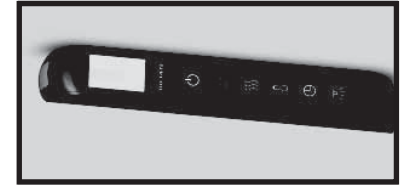

#9 Remote

IMPORTANT: THIS IS DATED INFORMATION. Parts must be ordered from a dealer or distributor. **Hearth and Home Technologies does not sell directly to consumers.** Provide model number and serial number when requesting service parts from your dealer or distributor.



Stocked at Depot

ITEM	DESCRIPTION	COMMENTS	PART NUMBER	
1	Heater Assembly includes Control Board and Fan		HEATER-BI36	Y
2	Rotisserie Motor, Rod & 3 Screws		ROTISSERIE-BI36	Y
3	LED Strips, 3 Strips		LED-BI36	Y
4	Log/Grate Assembly		LOGS-BI36	Y
5	Refractory Kit		REFRACTORY-BI36	Y
6	Flame Screen		FLAME-BI36	Y
7	Front		FRONT-BI36	Y
8	Glass		GLA-BI36	Y
9	Remote		REMOTE-SF-ELEC	Y
	Hardware Bag		HRDW-BI	Y
	Includes: Mounting Brackets, Screw (ST4 x 8), Screws (ST4 x 12)			
	Installation Manual		2040-900	

F. Contact Information



SimpliFire, a brand of Hearth & Home Technologies Inc.
7571 215th Street West, Lakeville, MN 55044
www.hearthnhome.com

Please contact your SimpliFire dealer or customer / technical support
(877-320-0730) with any questions or concerns.
For the location of your nearest SimpliFire dealer,
please visit www.hearthnhome.com.

- NOTES -

NOTICE



- Important operating and maintenance instructions included.

DO NOT DISCARD THIS MANUAL

- Read, understand and follow these instructions for safe installation and operation.

- Leave this manual with party responsible for use and operation.

